



Silicon Hill

Síť klubu Silicon Hill

Uživatelé, Správa

- Uživatelé (~3500 členů)
 - ▶ Musí být členy klubu Silicon Hill
 - ▶ Registrace u Registrátorů
 - ▶ Platba členského příspěvku
- Registrátoři
- Admini bloků a jejich zástupci
- Síťová skupinka, Správce sítě

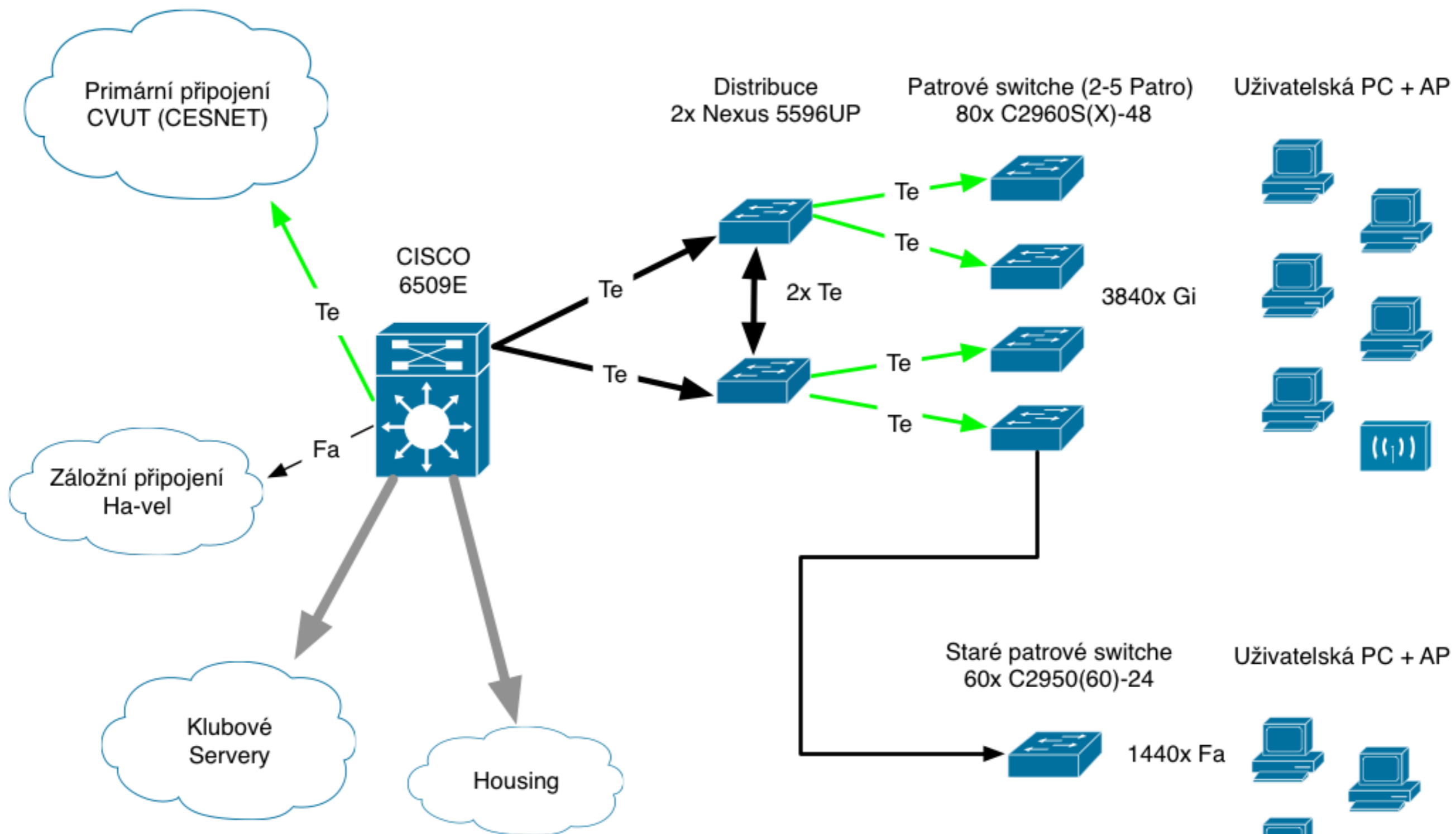

Te = Ten Gigabit Ethernet ~ 10 Gbps
 Gi = Gigabit Ethernet ~ 1000 Mbps
 Fa = Fast Ethernet ~ 100 Mbps
 Po = Port channel

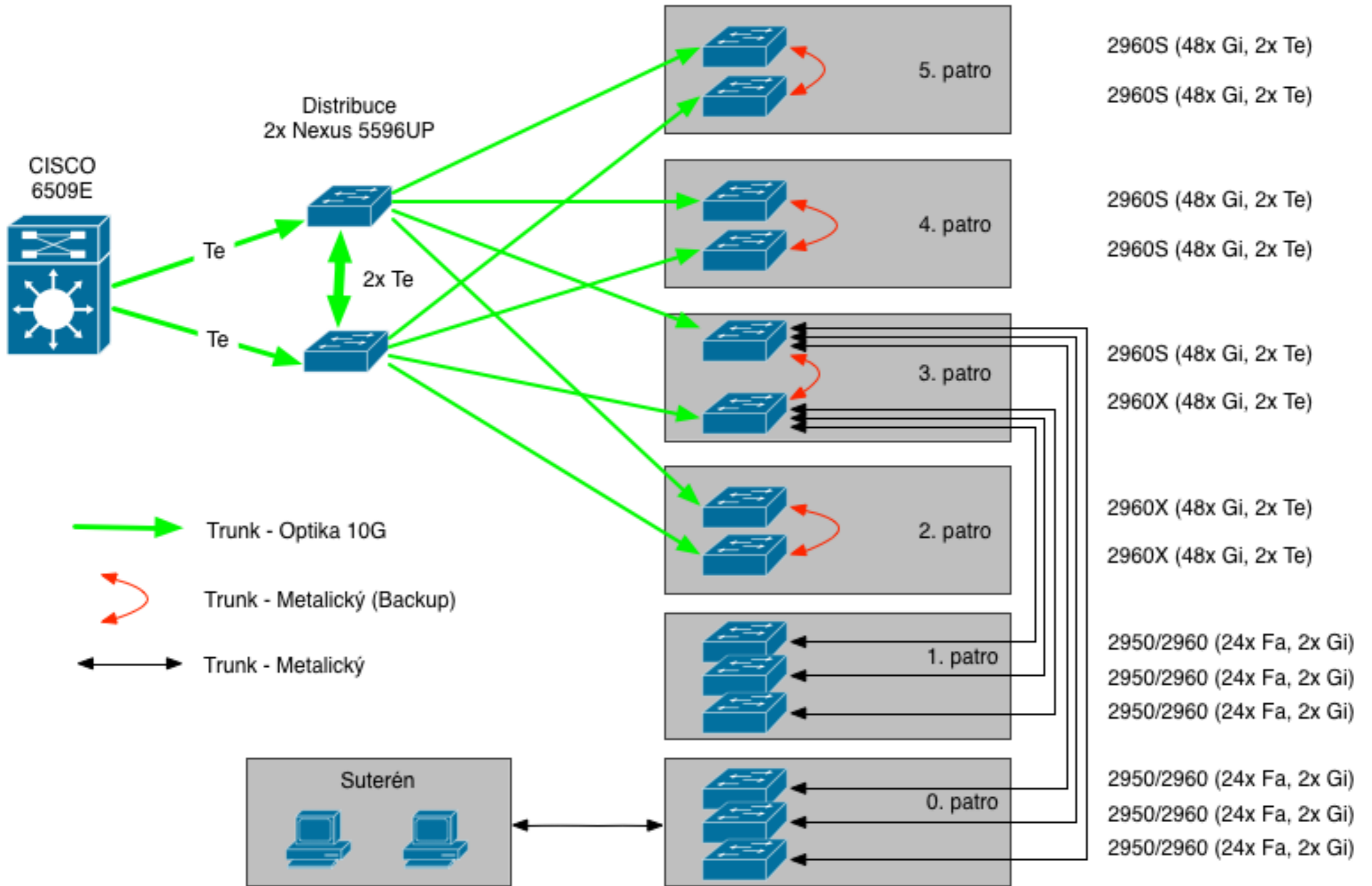

Access porty

- 10/100/1000BASE-T
- Administrativně přidělované IP adresy
- Na portech
 - ▶ MAC port security
 - ▶ IP access list (anti-spoofing)
 - ▶ DHCP Snooping, DHCPv6 Guard
 - ▶ [802.1x – UN,PW,MAC,Port]



IPv4 Konfigurace portu

```
1 interface GigabitEthernet1/0/15
2   description 515A
3   switchport access vlan 61
4   switchport mode access
5   switchport port-security
6   switchport port-security mac-address 00##.####.d622
7   ip access-group ACL-Gi1/0/15 in
8   no cdp enable
9   spanning-tree portfast
10  spanning-tree bpduguard enable
11 end
12
13 Standard IP access list ACL-Gi1/0/15
14   10 permit 0.0.0.0
15   20 permit 147.32.116.56
16   30 deny any
```

IPv6 Konfigurace portu

```
1 interface GigabitEthernet1/0/15
  ...
8  ipv6 traffic-filter ACLv6-Gi1/0/15 in
9  ipv6 nd rguard
10 ipv6 dhcp guard attach-policy dhcp-client
  ...
14 end
15
  ...
20
21 IPv6 access list ACLv6-Gi1/0/15
22   permit ipv6 host 2001:718:2:61::5A any sequence 10
23   permit ipv6 FE80::/64 any sequence 20
24   deny ipv6 any any sequence 30
25
```



Layer 2

- 62 VLAN
- 1 VLAN – 1 subnet
- Nepoužíváme VTP
- Rapid-PVST
- Virtual Port Channel

Layer 3

- 1 Router – C6509
- Directly connected
- NAT na FWSM, Logy
- Policy Based Routing
- Border In/Out ACL
- PIM SM (Multicast)
- Static default route

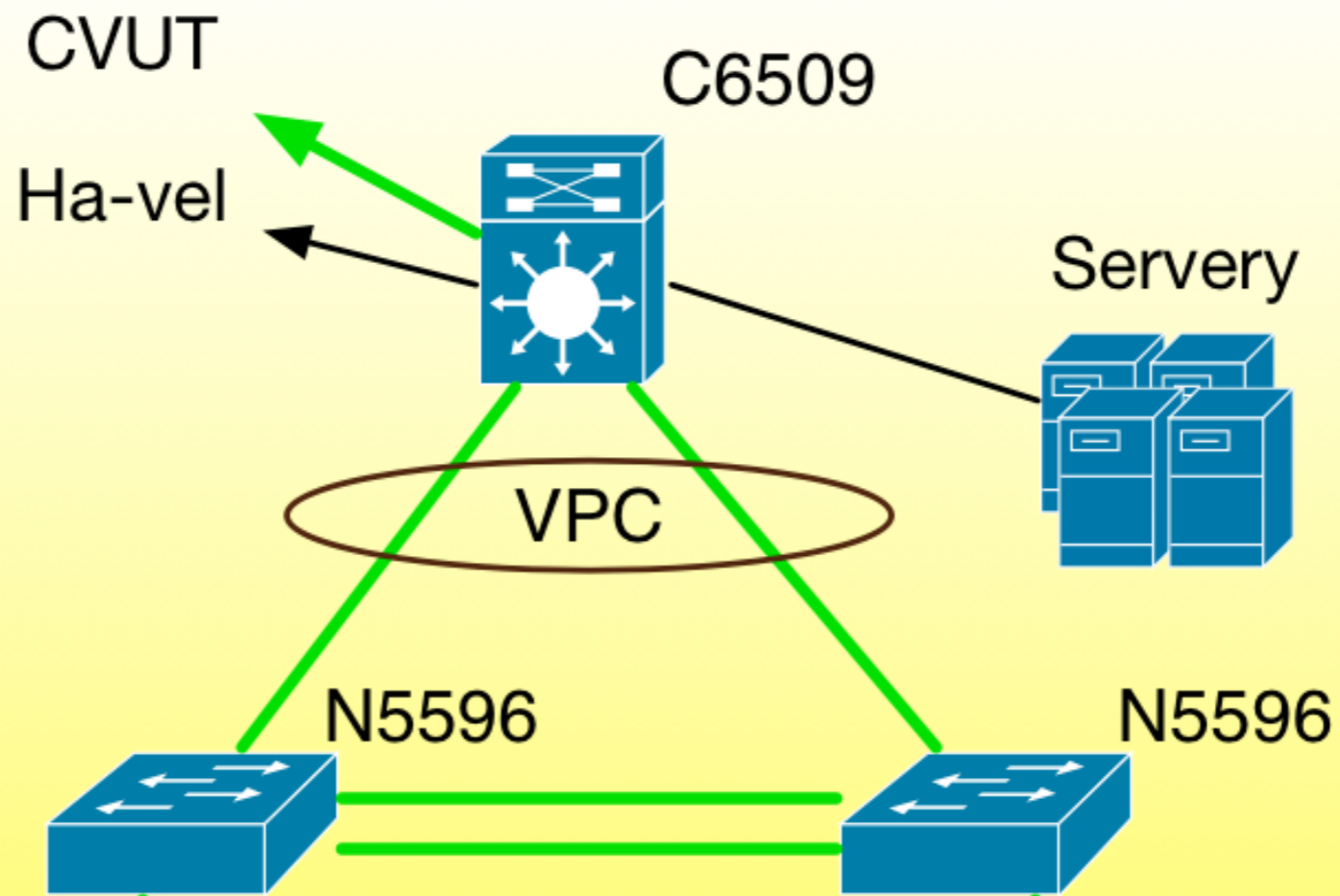
Centrální serverovna



Patro bloku

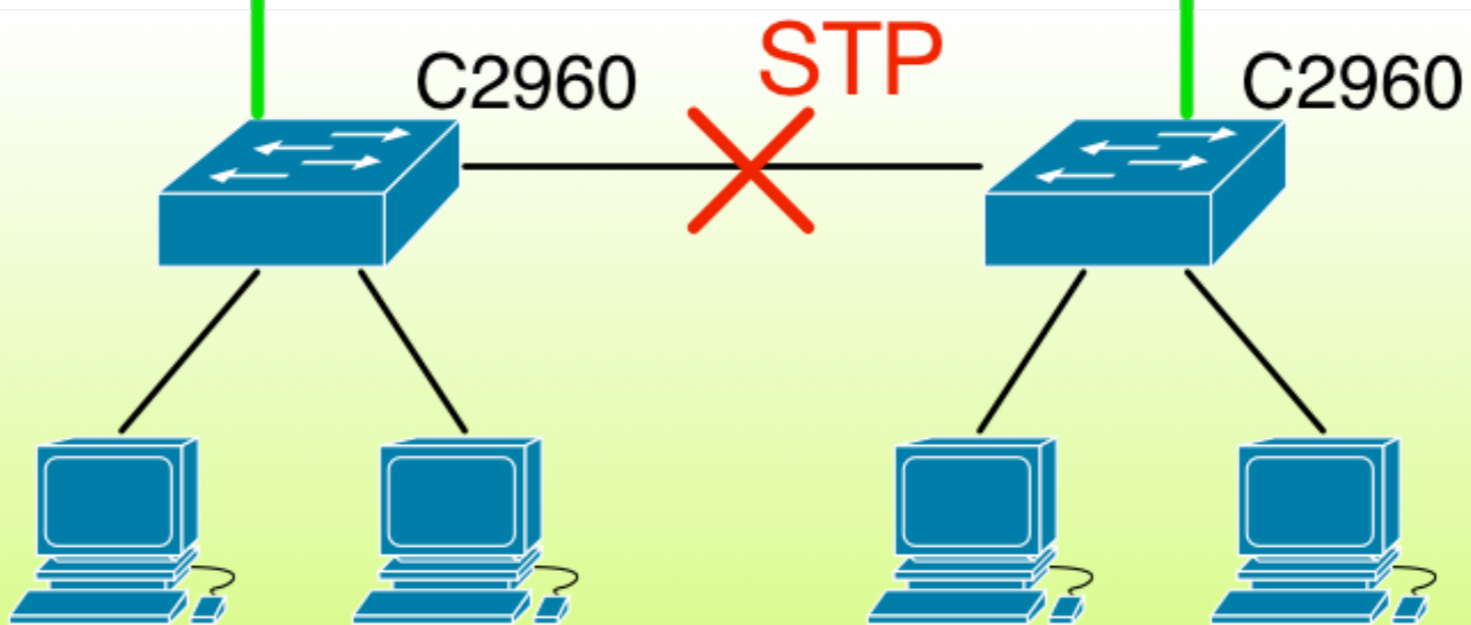

IP Rozsahy

- ČVUT (CESNET)
 - 147.32.112.0/20
 - 147.32.30.0/23
 - 2001:718:2::/56
- Ha-vel
 - 213.195.201/25
 - 2a02:570:8f::/56
- Vnitřní adresace
 - 10.0.0.0/8 – Síťové prvky
 - 192.168.0.0/16 – Ostatní zařízení
 - 172.16.0.0/16 – NAT ČVUT
 - 172.17.0.0/16 – NAT Ha-vel



Správa a dohled

- Správa síťových prvků
 - ▶ AAA: tacacs+ (SSO, Live + 24h Reporty)
 - ▶ Záloha konfigurace: rancid (24h)
 - ▶ Logování: Observium, rsyslog
 - ▶ Monitoring: Observium, Icinga
- Informační systém klubu Silicon Hill
 - ▶ Konfigurace access portů
 - ▶ Kontrola globální konfigurace, MOTD
 - ▶ DHCP, DHCPv6, DNS, SMTP
 - ▶ LDAP, RADIUS, Tacacs

GOV 1

GOV 2

NGINX load balancer
is.sh.cvut.cz
+ ssl offload

NGINX load balancer
static.is.sh.cvut.cz

NGINX pro assets

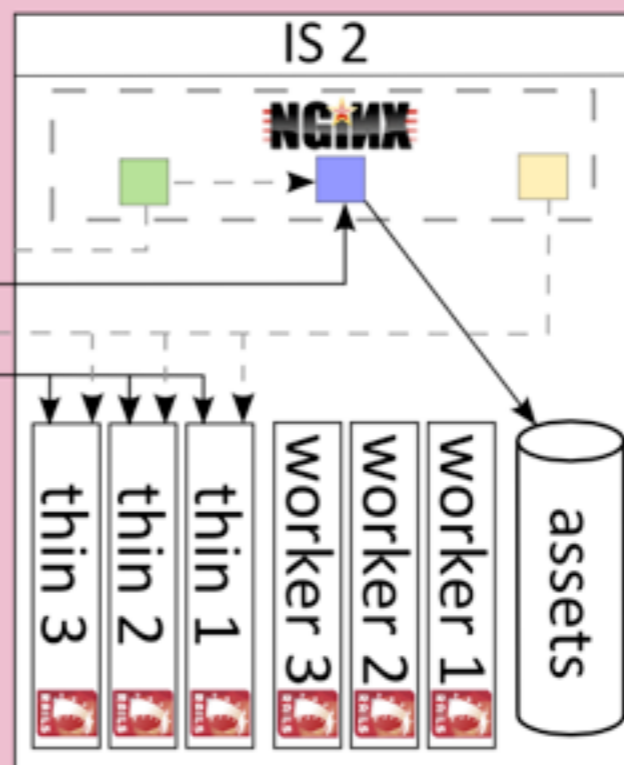
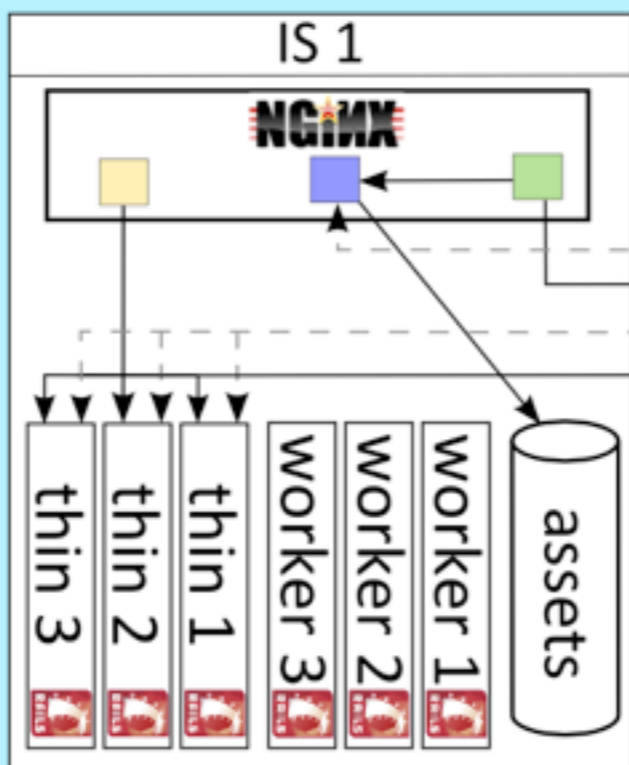

LDAP 1



RADIUS

PGSQL 1



SVC 1

PowerDNS

ISC DHCPD
+ SH DBI Patch

SMTP (Postfix)

SVC 2

PowerDNS

ISC DHCPD
+ SH DBI Patch

SMTP (Postfix)

LDAP 2



RADIUS

PGSQL 2

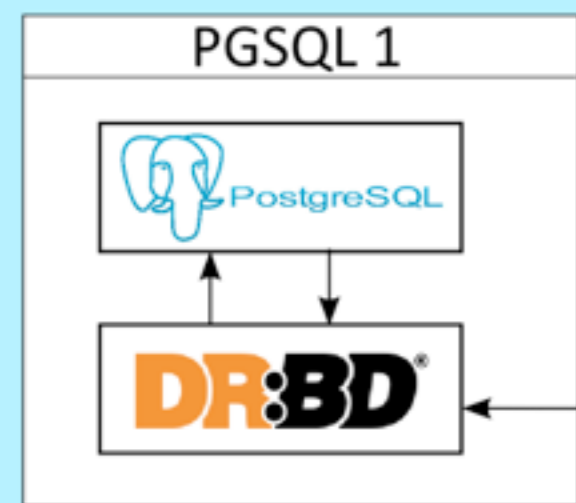
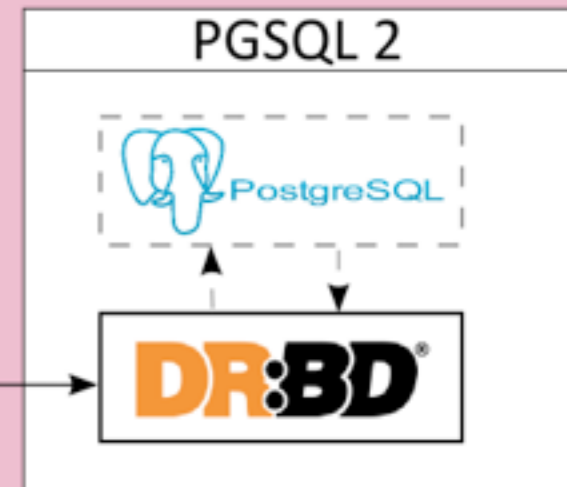
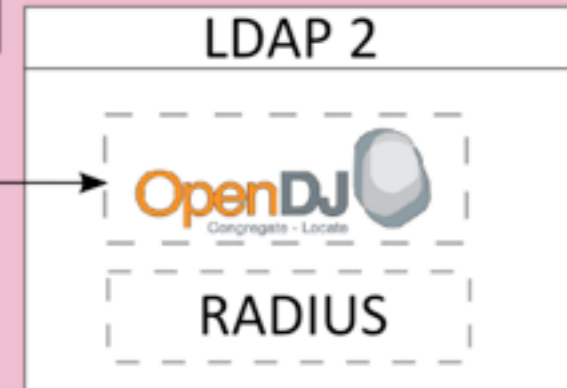
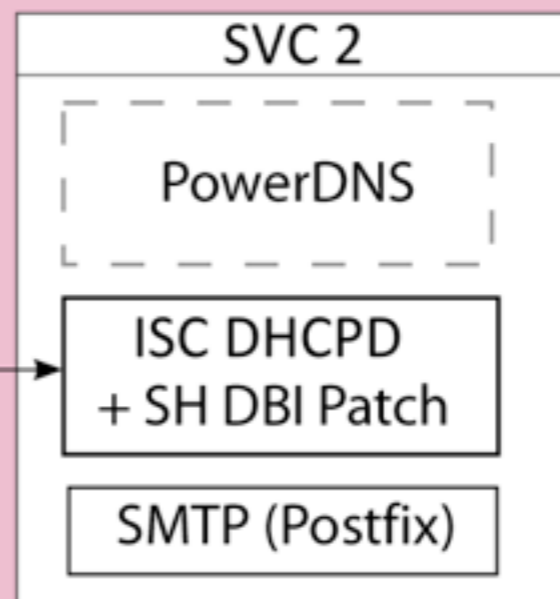
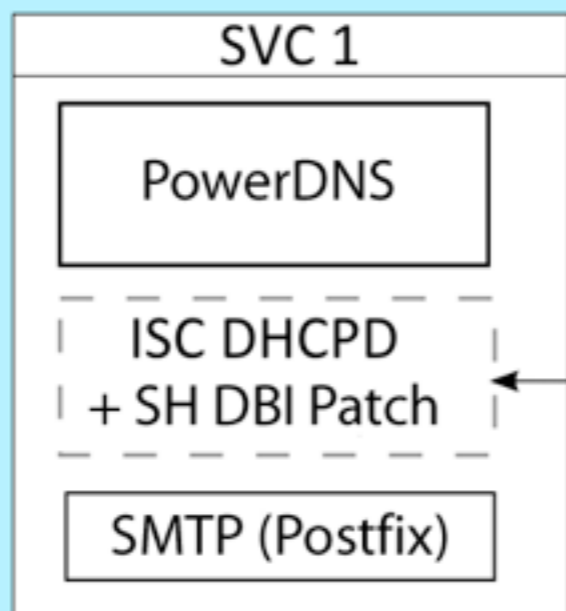
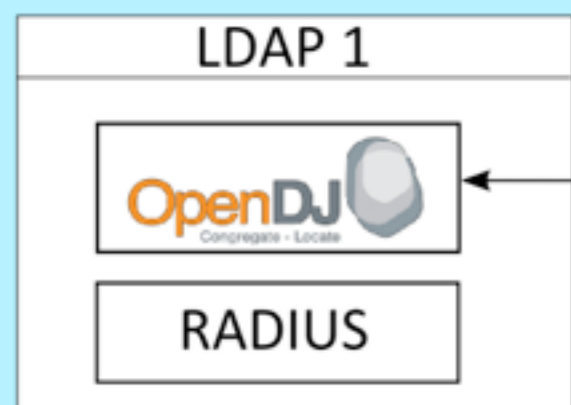



Sign in to IS

[Forgotten password?](#)

Recognized user

UID: 20288
 Name: Bronislav Robenek
 Username: robnek
 Email: b.robnek@sh.cvut.cz

Nearest registrators

Room	Name
Blok 6/240	Jakub Kameniar
Blok 6/305	Vojtěch Dvořák
Blok 6/330	Slavomír Kožár

Silicon Hill membership

You have to be registered and pay membership fee to become a member. Students living in the Strahov dormitory can be registered by the people called registrátor. Others can be registered in the club office. By signing you accept all terms and conditions of the Silicon Hill and become member of the Studentská unie ČVUT (CTU Student Council).

Information system

System for maintaining membership, membership fees evidence, and network devices managing. For comments and bug reports use [bug reporting system](#).

Network access

To access wired or wireless network you will need registered device and login credentials of your account. Authentication is provided by IEEE 802.1x, or MAC address (depends on switch configuration).

Pre-registration

Fill in online pre-registration form and Registration form (you can get one from registrátor) to make registration process easier and faster. Then, registrátor can finish your registration. You will need your pre-registration number, Registration form and ID.

Membership fees

Services will be activated after the registration and membership fee payment. Membership fees can be paid by bank transfer, postal order or cash deposit in the bank. If you are not sure how and where to pay, you can use our Membership fees calculator.

```
robenek — ssh — 83x35
ssh 10.7.150.1
Last login: Wed Oct 22 16:47:43 on ttys004
robenek@br-wifi:~$ ssh 10.7.150.1
Password:

+-----+
|                                     |
|               Cisco Systems (WS-C2960S-48TD-L) |
|               b0705a-esw, Blok 7/5vzd         |
|                                     |
+-----+

+-- Informace o switchi -----+
| Admin:                (Cajovna/Cajovna)      |
| Posledni autoconfig: 22.10.2014 04:00:06    |
+-----+

+===== TVOJE TODO PRO TUTO SESSION =====+
| Na switchi chybi nasledujici konfigurace:   |
| errdisable recovery cause bpduguard        |
| errdisable recovery cause link-flap        |
| interface Vlan1                             |
|   shutdown                                  |
| interface Vlan201                            |
|   description MANAGEMENT                    |
| no spanning-tree optimize bpdu transmission |
| ip ssh version 2                             |
| ip tacacs source-interface Vlan201          |
| tacacs-server host                           |
| tacacs-server key 7                          |
| line con 0                                    |
|   exec-timeout 30 0                          |
| line vty 0 4                                  |
|   logging synchronous                       |
|   transport input ssh                       |
```



Přehled síťového provozu

Vytížení sítě [Aktivita síťů](#)

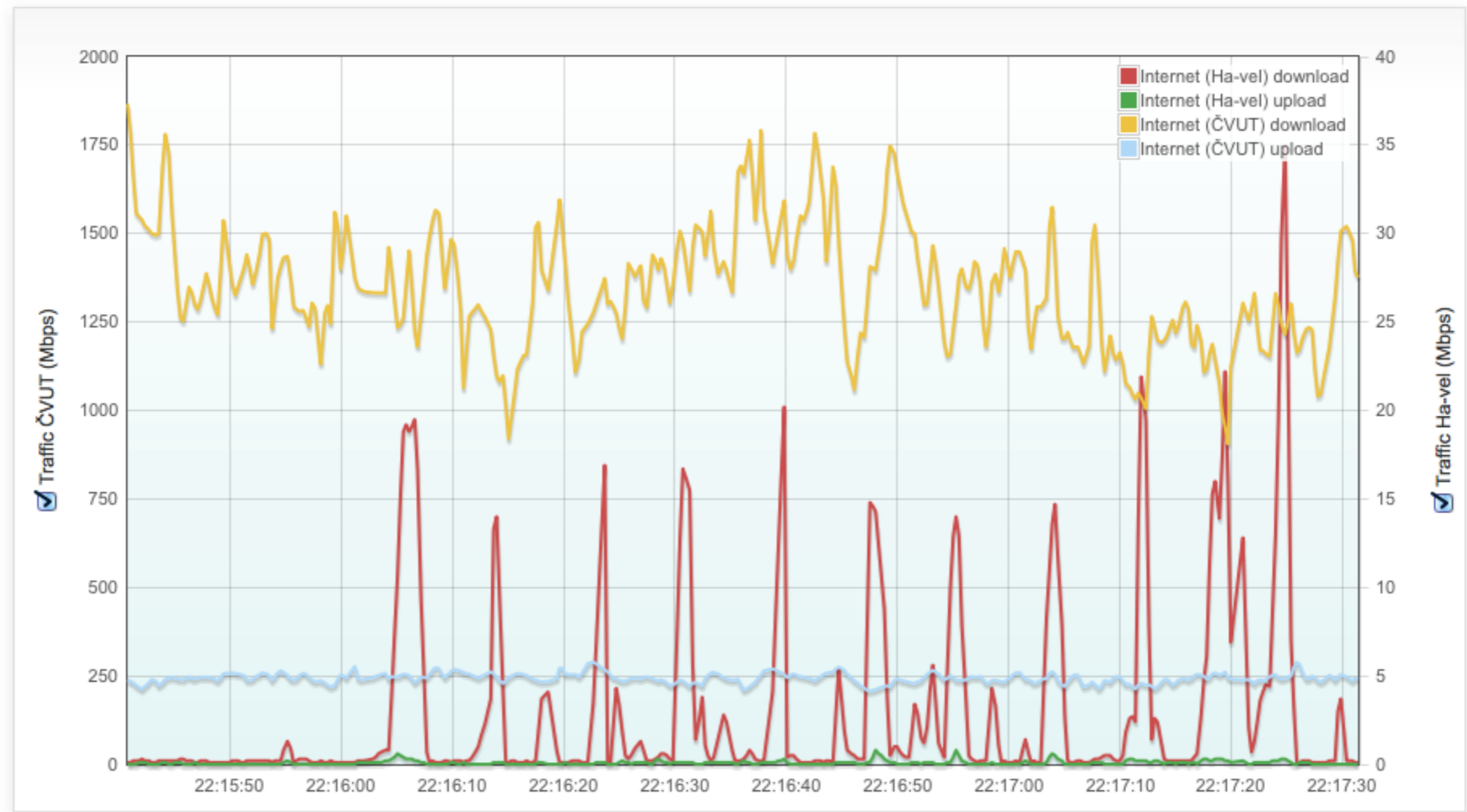



Aktivita síťů

[Vytížení sítě](#)[Aktivita síťů](#)

```
dsicner@b0401a-esw# configure terminal !-- 22.10. 16:28:16
dsicner@b0401a-esw# radius-server deadtime 5 !-- 22.10. 16:28:38
dsicner@b0401a-esw# radius-server directed-request restricted !-- 22.10. 16:28:50
dsicner@b0401a-esw# radius-server vsa send authentication !-- 22.10. 16:28:59
dsicner@b0401a-esw# radius-server host 147.32.30.### auth-port 2345 key ***** !-- 22.10. 16:30:13
dsicner@b0401a-esw# exit !-- 22.10. 16:30:44
dsicner@b0401a-esw# write !-- 22.10. 16:30:45
dsicner@b0401a-esw# show running-config !-- 22.10. 16:31:15
dsicner@b0401a-esw# logout !-- 22.10. 16:31:32
dsicner@b0401b-esw# configure terminal !-- 22.10. 16:31:54
dsicner@b0401b-esw# interface Vlan 1 !-- 22.10. 16:31:59
dsicner@b0401b-esw# ip route-cache !-- 22.10. 16:32:02
dsicner@b0401b-esw# exit !-- 22.10. 16:32:03
dsicner@b0401b-esw# interface Vlan 201 !-- 22.10. 16:32:08
dsicner@b0401b-esw# ip route-cache !-- 22.10. 16:32:11
dsicner@b0401b-esw# exit !-- 22.10. 16:32:13
dsicner@b0401b-esw# no ntp clock-period !-- 22.10. 16:32:17
dsicner@b0401b-esw# exit !-- 22.10. 16:32:18
dsicner@b0401b-esw# write !-- 22.10. 16:32:20
dsicner@b0401b-esw# show running-config !-- 22.10. 16:33:07
dsicner@b0401b-esw# reload !-- 22.10. 16:33:26
robenek@gw#
```

netadmins-rancid | GitLab





















GL git.sh.cvut.cz/netadmins-rancid/tree/master/SH/configs

netadmins-rancid

Search

Files Commits Network Graphs Wiki Settings

master > netadmins-rancid / SH / configs

Name	Last Update	Last Commit	dc9452aebf8 – updates of group SH	history
..				
 10.0.0.1	7 days ago	 rancid	updates of group SH	
 10.0.0.2	3 days ago	 rancid	updates of group SH	
 10.0.0.3	3 days ago	 rancid	updates of group SH	
 10.0.1.1	3 days ago	 rancid	updates of group SH	
 10.0.3.1	3 days ago	 rancid	updates of group SH	
 10.0.4.1	3 days ago	 rancid	updates of group SH	
 10.1.90.1	3 days ago	 rancid	updates of group SH	
 10.10.100.1	3 days ago	 rancid	updates of group SH	
 10.10.100.2	3 days ago	 rancid	updates of group SH	
 10.10.100.3	3 days ago	 rancid	updates of group SH	

Vyřízení sítě

Aktivita síťů

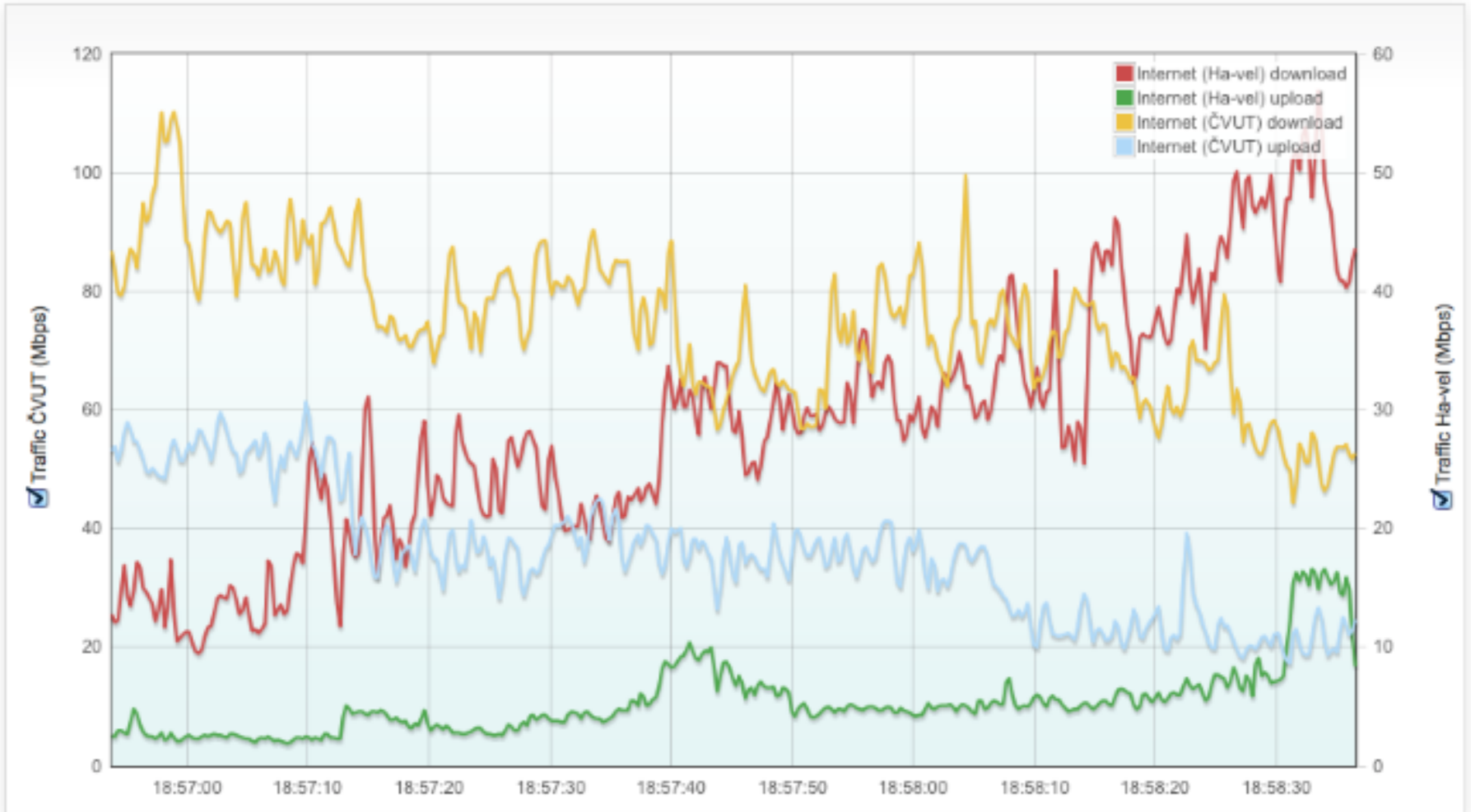

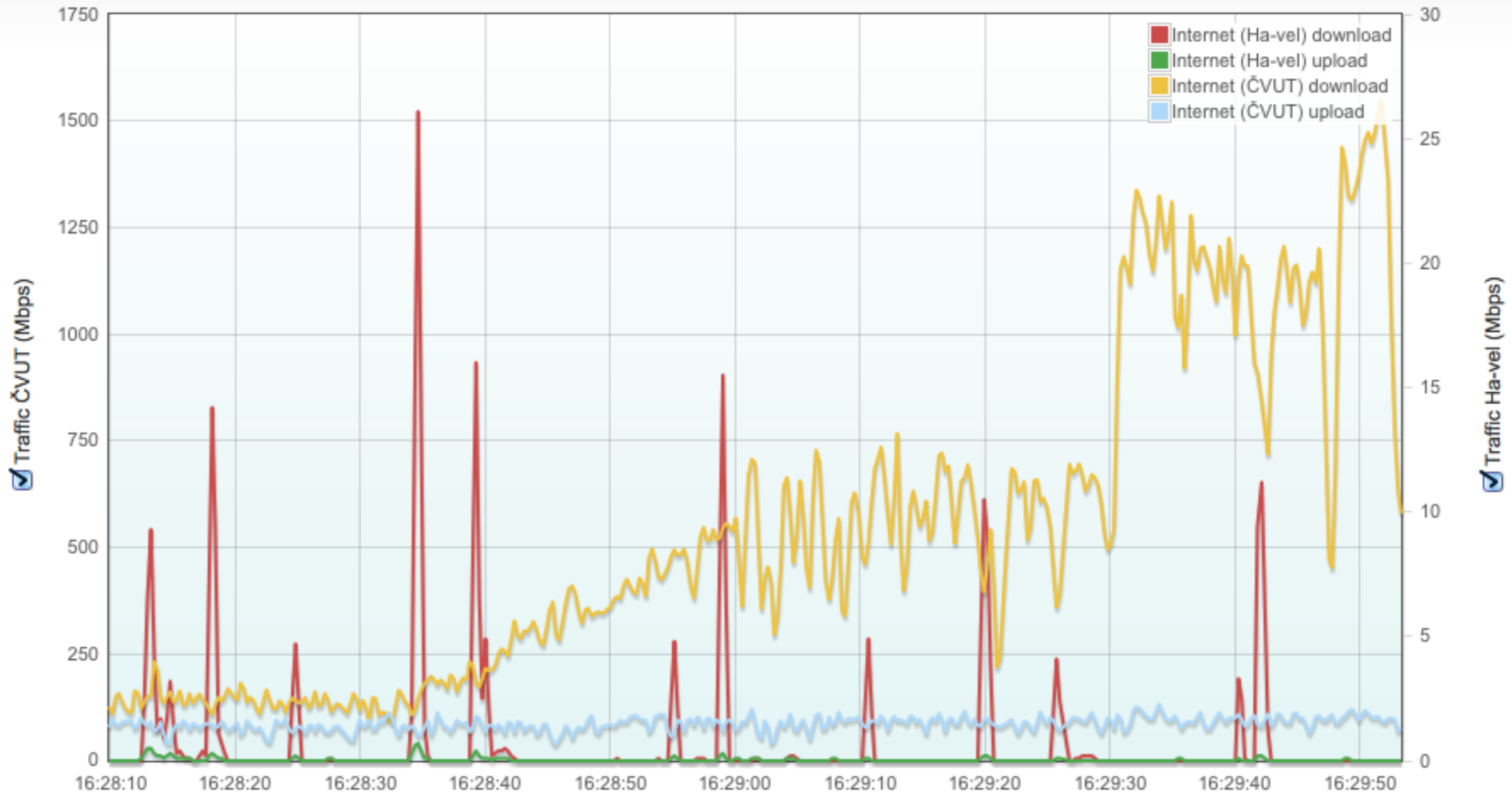

Možnosti jak se zapojit

- Centrálně
 - ▶ Správa centrálních prvků (C6509,N5596,ASA5515)
 - ▶ Pomoc blokům
 - ▶ Dokumentace
 - ▶ Wi-Fi Skupinka
- Na blocích (Správa blokových prvků)
 - ▶ Admin bloku, Zástupce admina
 - ▶ Registrátor
- Informační systém



Vzdělávání

- Síťové čtvrtky
<http://sit.sh.cvut.cz>
- SUT – Středisko Unixových Technologii
<http://sut.sh.cvut.cz>
- Síťářina v praxi
<http://sitarina.sh.cvut.cz>
- Cisco Networking Academy
<http://cna.su.cvut.cz>



Silicon Hill

Kontakty

- Netadmins
 - ▶ <netadmins@sh.cvut.cz>
 - ▶ <wifi@sh.cvut.cz>
- Řešení incidentů
 - ▶ <abuse@sh.cvut.cz>
- Informační systém
 - ▶ <https://is.sh.cvut.cz>
 - ▶ <is@sh.cvut.cz>



